

OWNERS MANUAL

GEWA Digital Piano **UP 280 WK**



Bedienungsanleitung | Owners manual | Mode d'emploi | Manual de instrucciones
www.gewapiano.com



Please read this user manual carefully before operating the instrument and take note of the safety information!
Please keep the user manual for reference purposes.

Manufacturer:
GEWA music GmbH
Werkstraße 1
08626 Adorf
GERMANY

www.gewamusic.com

Version 1.0

Latest Release 01.09.2016

1	SAFETY INFORMATION	5
1.1	General Information	5
1.2	How to use/play the Piano	6
1.3	Improper Use	6
1.4	Safety Precautions	7
1.5	CE label	8
1.6	Recycling	8
2	PARTS SUPPLIED WITH THE PIANO	9
3	ASSEMBLY INSTRUCTIONS	10
4	GETTING STARTED	12
4.1	Piano Controls	12
4.2	Function Keys and Pedals	13
4.3	Connector Panel	15
5	OPERATION	17
5.1	Switching on	18
5.2	DEMO function	18
5.3	Sound selection	18
5.3.1	Sound Combinations (Dual Sounds)	19
5.3.2	Sound Combinations (Split Sounds)	19
5.4	Reverb and Chorus / others	20
5.4.1	Reverb	20
5.4.2	Chorus and other DSP Effects	21
5.5	Metronome	22
5.5.1	Switching the Metronome on/off	22
5.5.2	Editing the Metronome	23
5.5.3	Time Signature Change	23
5.5.4	Setting the Metronome Volume	23
5.5.5	Editing the Metronome Tempo	23
6	FUNCTION MENU	24
6.0	List of Settings	25
6.1	Brilliance Settings	26
6.2	Transpose	26
6.3	Fine-tune	26
6.4	Max Phones Level	26
6.5	Input Reverb	27
6.6	Start Up Settings	27
6.7	Piano Information	27
6.8	Piano Settings	28
6.8.1	Keyboard Response	28
6.8.2	Sustain Pedal	29
6.8.3	Sympathetic Resonance	29
6.8.4	Temperament	30
6.9	Player Menu	30
6.10	USB Settings	31
6.11	System	31
6.12	MIDI Menu	32
6.12.1	MIDI Transmit Channel	32
6.12.2	Local Control	32
6.12.3	MIDI Program Change	32
6.12.4	Piano Modus	33
6.13	Registration	33

7	RECORD AND PLAYBACK FUNCTION	34
7.1	How to record Songs	34
7.2	Playing back Recordings	34
7.3	Editing Recordings	35
8	CONNECTING ACCESSORIES	36
8.1	Connecting Headphones	36
8.2	Connecting a Playback Device	36
8.3	Connecting an external Amplifier	36
8.4	Connecting a PC	36
8.5	Bluetooth Audio	37
9	ADDITIONAL INFORMATION	38
9.1	Glossary	38
9.2	Warranty	39
10	TROUBLESHOOTING	40
11	TECHNICAL INFORMATION	40

Dear Customer,

Thank you for purchasing our GEWA UP 280 digital piano!

With the GEWA UP 280 you have selected a top quality digital digital piano, giving you a highly impressive sound and playing experience with a huge extra set of additional and easy-to-use sounds and functions.

Your safety is very important to us! So please read the safety information carefully and take good note of the given information.

We suggest you to keep this user manual at a safe and known place, and to pass it on to a new owner or user of your UP 280.

1



NOTE

SAFETY INFORMATION

The manufacturer cannot be held liable for injury to persons or damage to property resulting from incorrect use of the device!

Only use your digital piano in accordance with the instructions given here!

1.1

SYMBOLS USED IN THE MANUAL

The following symbols are used to signal risks and to give advise:

Level of Risk	Symbol	Bedeutung	Definition
Serious Injuries		WARNING	Failure to observe the following safety instructions can result in serious injury or death.
Electrical Hazard		WARNING	Failure to observe the following safety instructions can result in serious injury or death by electrical hazards.
Minor Injuries and device damage		CAUTION	Failure to observe the following safety instructions can result in minor injuries and/or device damage
Notes		NOTE	Helps to avoid the injuries and damaging of the piano
Hints		HINT	Hints for optimized handling of your GEWA digital piano

1.2 HOW TO USE/PLAY YOUR GEWA DIGITAL PIANO IN THE RIGHT WAY

Please keep your digital piano in a dry environment.

- Audio accessories for audio playback (connected to the pianos in- or output) or for data communication can be connected. Accessories must match the relevant technical specifications (please therefore see chapter 11, technical data).
- Only and always use GEWA certified power adapters, and make sure that they are properly attached and connected. The power supply used must also meet the country voltage specifications (check plate on the adapter).
- The digital piano is only to be used as originally delivered. Any modifications to the piano are not allowed and result in a complete loss of warranty.
- The digital piano must be set up on safe weight-bearing, stable and even ground or platform able to support the weight (please therefore see chapter 11, technical data).

1.3 IMPROPER USE

- Exposing the digital piano to an open air or moist/rainy environment
- Setting up the piano in damp rooms
- Using power supplies not authorized by GEWA music, or connecting the piano to an electrical outlet in spite of mismatching local voltage specifications
- Playing the piano close to electrical or electronic devices, such as stereo systems, TV sets, radios or mobile phones. These devices can cause interferences and seriously effect and decrease the sound quality of your GEWA digital piano.
- Using extensively long audio leads can likewise interfere with the sound quality.
- Transport and setup up in conjunction with strong vibrations and shocks, dust and heat exposure (e.g.in vehicles or direct sunshine or both), should also definitely be avoided.



NOTE

The manufacturer cannot be held liable in case of damages in the following cases:

- Non-compliance with the safety instructions
- Improper handling
- Connecting incompatible in/output devices etc. or other 3rd party interface devices.

1.4

SAFETY PRECAUTIONS

Always follow the safety precautions given here. Non-compliance with the safety precautions may have serious consequences:

- Serious injury or even lethal accidents
- Electric Hazard
- Short circuits
- Damage
- Fire

Further and other risks are possible, therefore this list does not claim to be complete.

**WARNING****Electric hazard**

- Even low electric currents can lead to serious injuries and even death!
- Never open the digital piano.
- Never use damaged power supplies/cables.
- Install power supplies/cables firmly to avoid the risk of damage.
- Never place containments filled with water or liquids (vases, glasses etc.) on or near the piano.
- Never insert water or liquids into the digital piano or the keyboard.
- Never clean the digital piano with a wet cloth.
- Never plug in or unplug the piano with wethands and never pull on the cable as it may be damaged.
- If liquids or water accidentally get into the digital piano, unplug it immediately. In all of the above cases have the digital piano checked by your authorized GEWA customer service.

**WARNING****In case of unexpected and unusual behavior of the piano**

- Switch the digital piano off or unplug it immediately if:
 - there is a sudden loss of sound while the piano is in use,
 - the digital piano emits an unusual smell or smoke.
- It is essential to have the digital piano checked by your GEWA customer service.

**WARNING****Fire prevention**

- Open flames such as from candles or oil lamps can tip over and cause a fire.
- Never bring open fire on or near to the digital piano!

**CAUTION****Damaging the digital piano**

- Mismatching electrical voltages can damage the digital piano. Operate the digital piano only within the correct voltage range (marked on the corresponding specs plate).
- Only use the power supply and power cable supplied with the device.
- Never place the power cable near to heat sources such as radiators or radiant heaters.
- Do not sharply bend the cable, or damage it otherwise (!risk of cable break!).
- Position the power cable in a way to avoid tripping or anything heavy rolling over it.
- Do not place any objects on the power cable.
- Check the power supply regularly and remove any visible dust or dirt on the device.

**CAUTION****Thunderstorms can also damage your GEWA digital piano**

- Thunderstorms can produce electrical surges able to damage your digital piano
- During thunderstorms, or if you will not use your digital piano for a while, we suggest you to unplug your digital piano completely from the electrical system.

1.5

CE LABEL



Your GEWA digital piano complies with the requirements of the EU directives:

2004/108/EC on the approximation of the laws of the Member States relating to electromagnetic compatibility and repealing Directive 89/336/EEC. Compliance with the above directives is confirmed by the CE label on the device. The declaration of conformity can be viewed at the following address:

GEWA music GmbH
Werkstraße 1
08626 Adorf
GERMANY

1.6

RECYCLING



In case your digital piano needs to be disposed, take it to your local community waste management service location (e.g. disposal companies, recycling centers).

The displayed symbol requires that devices labeled with this symbol must be disposed separately from household waste. Under the Electrical and Electronic Equipment Act, owners of devices marked with this symbol are required by federal law to deposit waste electrical and electronic equipment in a separate waste collection.

Please help us with your contribution to protect the environment by not depositing your old electric equipment with the general household waste.

2

PARTS SUPPLIED WITH THE PIANO

Check the content of the package for completeness before starting with the assembly.

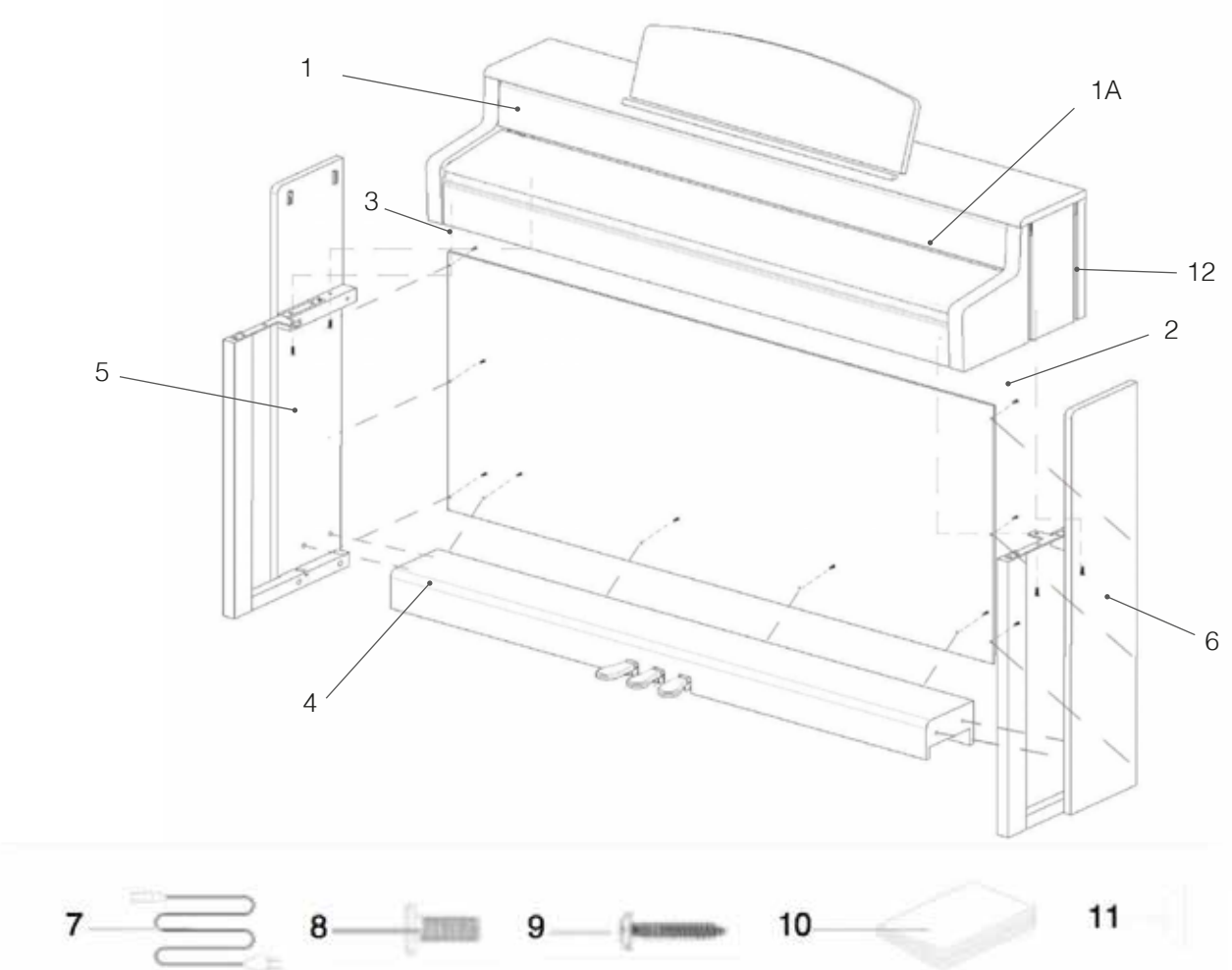

Pos.	Description	Pcs.
1	Console with keyboard	1
1A	Rollable Keyboard Cover	1
2	Rear panel	1
3	Headset Rest	1
4	Pedalboard with connector cable	1
5	Left side panel	1
6	Right side panel	1
7	Power supply and cable	1
8	Recessed head screw M6	9
9	Recessed head wood screw	10
10	Manual	1
11	Self-adhesive cable clips	2

3

ASSEMBLY INSTRUCTIONS

In this section we will show you how to easily set up your GEWA digital piano.

For the assembly you need:

- size 2 Phillips screwdriver
- second assisting person



NOTE

Do not firmly tighten the recessed head screws until all parts of your digital piano are aligned. Make sure you assemble your digital piano on level ground.

Now lets start assembling your GEWA digital piano

1. Release and unfold the wound up pedal cable (without illustration).
2. By using the recessed head screws M6 (10), connect the side panels (6 and 7) with the pedal board (4).
3. Apply the bracing of the pedal board (3) to the backside of the pedal board so that it snaps into the notch. Then screw it on using 4 recessed head screws.
4. Now screw on the bracing on to the back rear panel (2) with 4 recessed head screws.
5. Insert the console from above and flush mount it with the front edge. The console must lie flat on the screwed-on brackets for stability reasons. Then screw on the console (1) with 4 recessed head screws.
6. Level your digital piano and tighten all recessed head screws (6).
7. Place the plastic covers on all side panel boreholes (6 and 7).

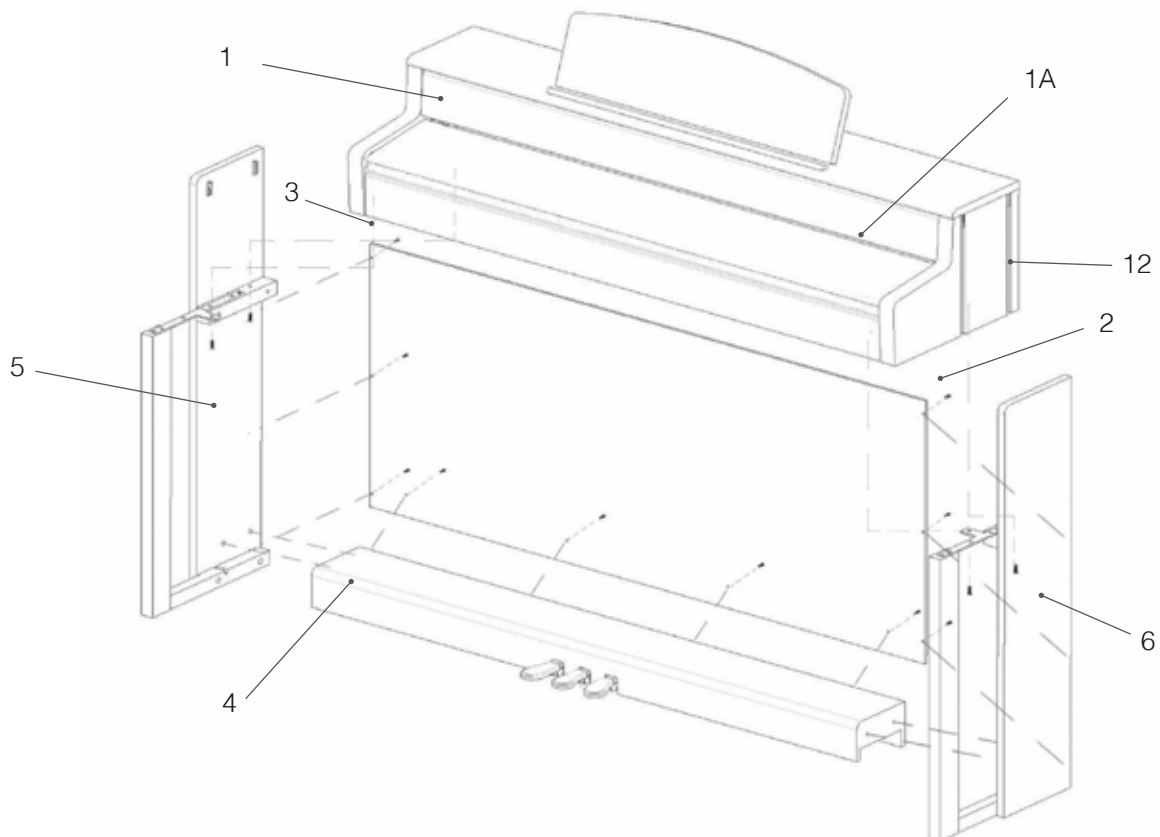

8. Now take your digital piano to its final position in the room and unscrew the support underneath the pedal board until it reaches the floor

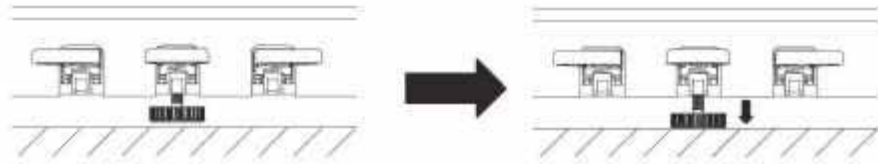

9. Plug in the pedal board cable in the right way (it should slide on easily without the use of force) to the socket on the bottom side of the console (1) and plug the power supply (8) into the power socket on the rear of the piano (without image).

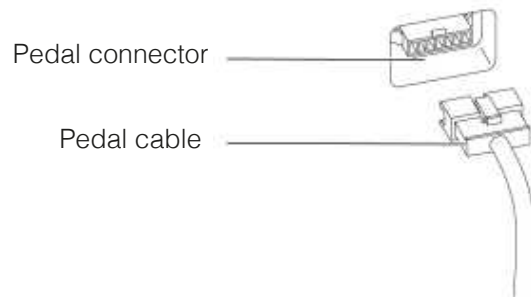

10. Please set up the music rest as shown below

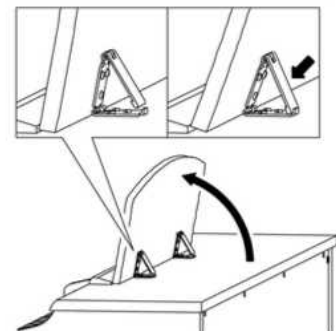

THIS IS HOW TO OPEN THE KEYBOARD LID



CAUTION

Please make sure to always use both hands to open or close the lid.

To open the lid please follow below drawing. In the opposite way the lid can then be closed again

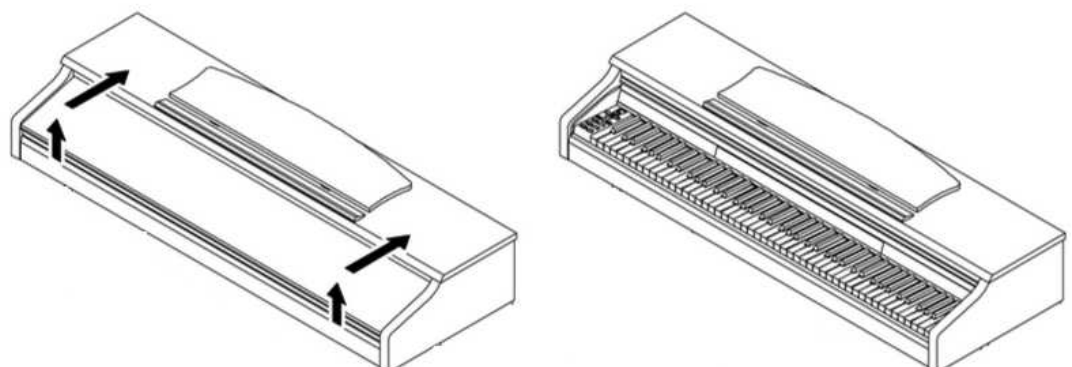



NOTE

FOR KEYBOARD STAND USE

It is also possible to use a keyboard stand in stead of the console. In this case place the keyboard stand on level ground and position it centrally. If possible the speakers on the bottom of the piano should not be touched by the stand. For the connection with a standard sustain pedal you can use the 6,3mm jack socket on the rear panel.

4

GETTING STARTED

Now let's have a look on to the controls of your GEWA digital piano

4.1

THE CONTROLS OF YOUR DIGITAL PIANO

Your GEWA digital piano features the following controls:

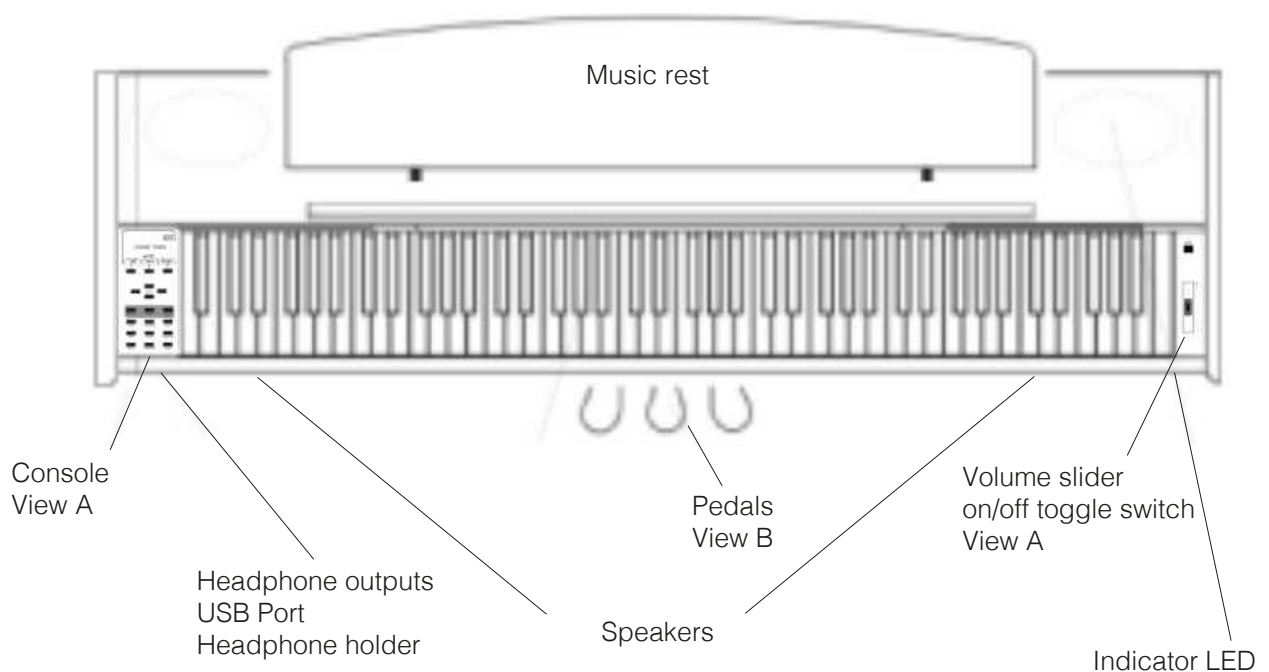

4.2 FUNCTION KEYS AND PEDALS

View A

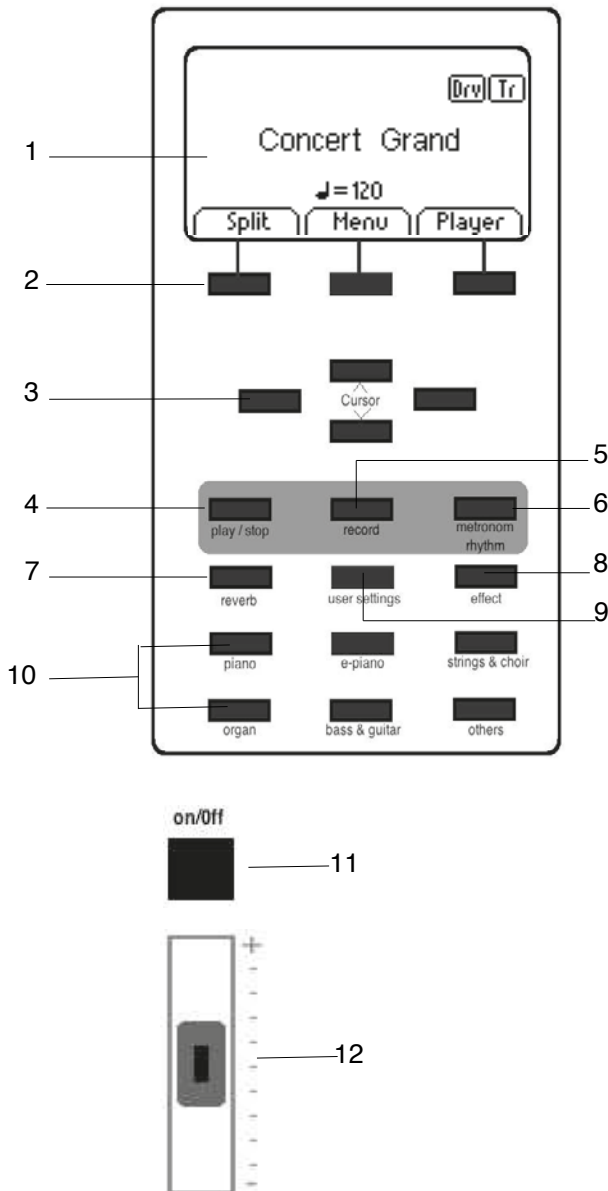

1 Display

provides settings and status information.

2 Softbuttons

Function dedicated Buttons.

3 Cursor buttons

Navigation to and within functions and function groups

Recording related buttons

4 play/stop

Start / Stop for recorded pieces of music.

5 record

This sets your GEWA Digital Piano to record standby mode

6 Metronome and metronome functions

With this button the metronome can be switched on/off and edited.

7 Reverb button

Turns the reverb on/off and, when longer depressed, enters the edit mode

8 Chorus and other effects

Turns the Chorus and other effects on/off and, when longer depressed, enters the edit mode

9 user settings

In this section you can create custom registrations

10 Group Sound Button

With these buttons you can navigate through the various sounds of your GEWA Digital Piano

11 on/off toggle switch

By toggling this switch you can turn the instrument on and off



NOTE: The switch does not latch in to position. A gentle toggle is all what is needed to switch the piano on or off

12 Volume Slider

Here you can set the overall volume of your GEWA digital piano



NOTE: Before switching the piano on we recommend you to set this slider to a middle position

View B

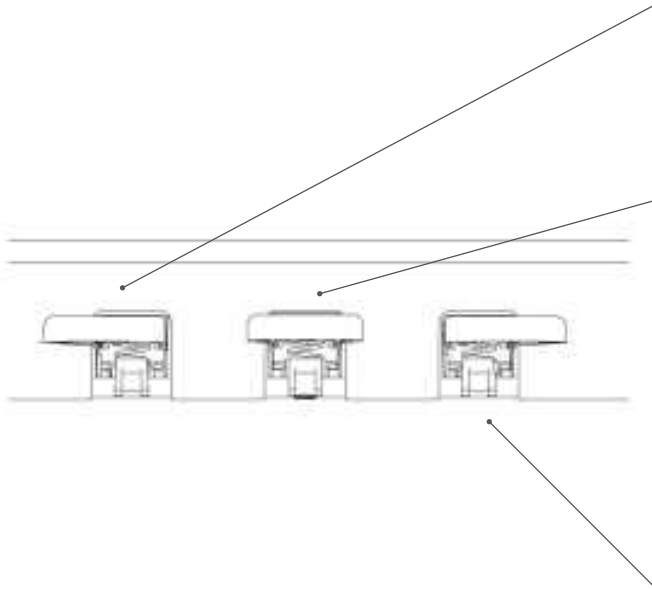

Una corda pedal (left)

The una corda pedal (soft pedal) simulates moving the pianos key mechanics closer to the stringboard, resulting in a more quiet and softer sound.

Sostenuto pedal (center)

The sostenuto pedal function is similar to the damper pedal function. When depressed while playing a key or a number of keys, this key or the keys is/are sustained until the pedal is released again. Unlike the damper pedal It sustains only those notes that are being held down when the pedal is depressed, allowing future notes played to be unaffected.

Damper/sustain pedal (right)

The damper/sustain pedal simulates the removal of the dampers from the strings like on an acoustic piano. Sounds that are played after pressing the damper/sustain pedal sound considerably longer. Includes also half-pedaling techniques.

4.3 CONNECTORS (REAR SIDE OF THE CONSOLE)

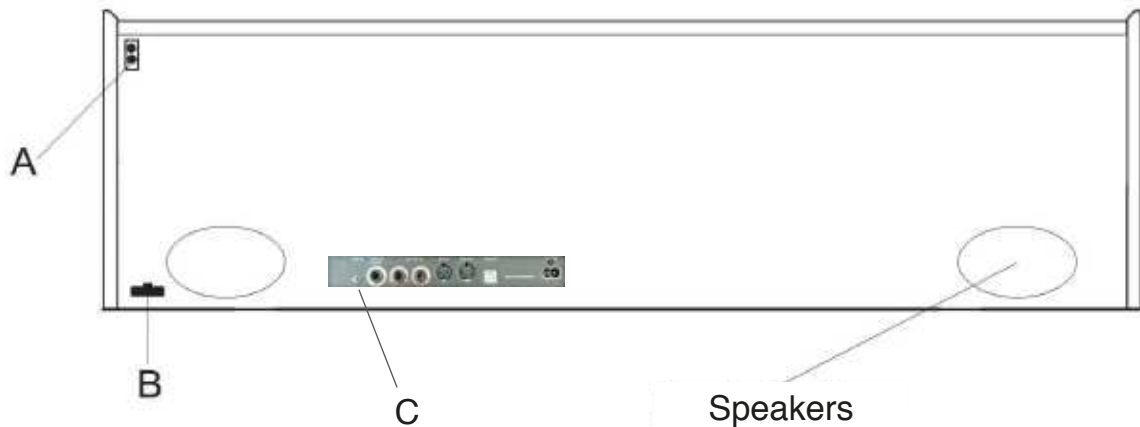

THE CONSOLE - BOTTOM SIDE CONNECTORS (C)

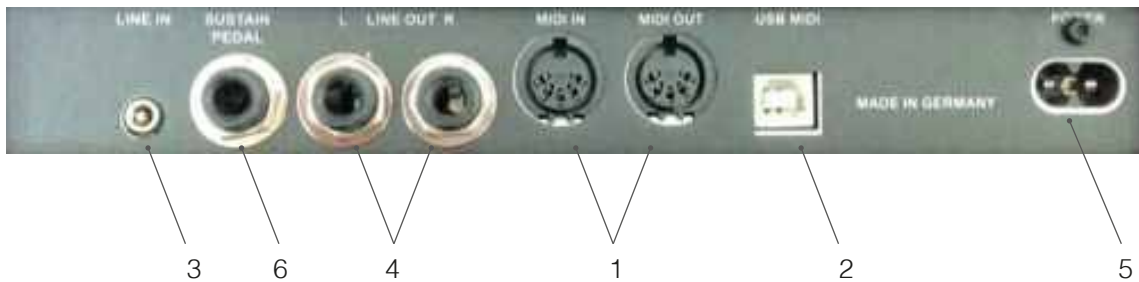

View (A)



2 headphone outputs (6.3 mm jack)

Connect your headphones here. Also there is a USB connector to insert a USB device (like a USB stick) for e.g. recorded audio playbacks

View (B)



Pedal cord jack

Connect the pedal cord here.

View (C)

1 MIDI-connector

Connect MIDI devices here to utilize the MIDI functions of your digital piano.

2 USB-B connector

Connect your digital piano to your PC with this interface.

3 LINE IN

Connect an output device (e.g. MP3 player) to your digital piano here. The signal is looped through your digital piano for a combined output with the sounds being played. This can be used e.g. for Playback accompaniment in rehearsals.

View C	4 LINE OUT R/L	Connect these outputs with a receiving audio device (e.g. amplifier or recording device) to e.g. record your playing on an audio recording/playback device.
	5 Mains Power Supply	Connect your digital piano with the supplied power adapter.
	6 SUSTAIN	6.3 jack socket for the connection of any standard sustain pedal OR the supplied pedal.



NOTE

The LINE IN and LINE OUT connectors are defined as separate stereo channels L(left) and R(right). Use appropriate wiring to output or input stereo audio signals. (3.5 mm stereo jack)

5

USING/PLAYING YOUR GEWA DIGITAL PIANO



NOTE

All edited settings will be reset to the factory settings when you switch off your piano and back on again, except for balance, brilliance and volume control settings.

5.1

SWITCHING ON



TIP

Set the volume control to the middle position before switching the piano on.

1. Toggle the On-/Off switch on the right side of your digital piano (above the volume slider).
2. The **Reverb** and **Piano Sound Group LED** are illuminated. Also the LED indicator at the right front of the digital piano lights up.
3. Your GEWA digital piano is now ready to play.

5.2

DEMO FUNCTION

The DEMO function provides a fantastic overview of the various sounds of your digital GEWA digital piano.

This is how to activate the DEMO song function:

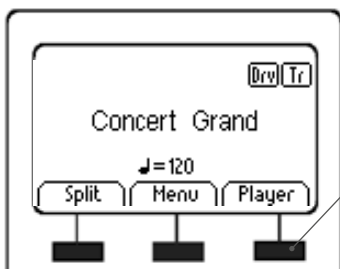

1. Press "PLAYER" function related softbutton

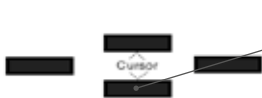

2. Press the upper and lower cursor keys, to highlight the demo song line



3. Now press the right cursor button to enter the list of demo songs. Then choose from the different DEMO-songs



4. Press the Play/Stop button, to start or stop the playback of a DEMO song. You can play along to a DEMO-song on your digital piano.



5. To leave the Demo song section simply press the "Exit" related softbutton.

5.3 SOUND SELECTION

Your GEWA digital piano features 37 exclusive sounds.
They are organized in the following groups:

Sound groups 1 - 6					
Piano	E-Piano	Strings Choir	Organ	Bass & Guitar	Others
Concert Grand	Seventy Three	Strings	Church Organ 1	Acoustic Bass	Clavi
Bright Grand 1	E-Piano 1	Slow Strings	Church Organ 2	Bass & Cymbal	Vibraphone
Mellow Grand 1	FM Piano	Choir	Drawbar Organ	Finger E-Bass	Marimba
Mellow Grand 2	Wurky	Slow Choir	Jazz Organ 1	Fretless Bass	Celesta
Upright Piano		Synth Strings	Jazz Organ 2	Picked Bass	French Accord
Rock Grand		OB Saw	Mellow Organ	Nylon Guitar	
Harpichord		Dark Pad Synth		Steel Guitar	
		Synth Bell Pad			

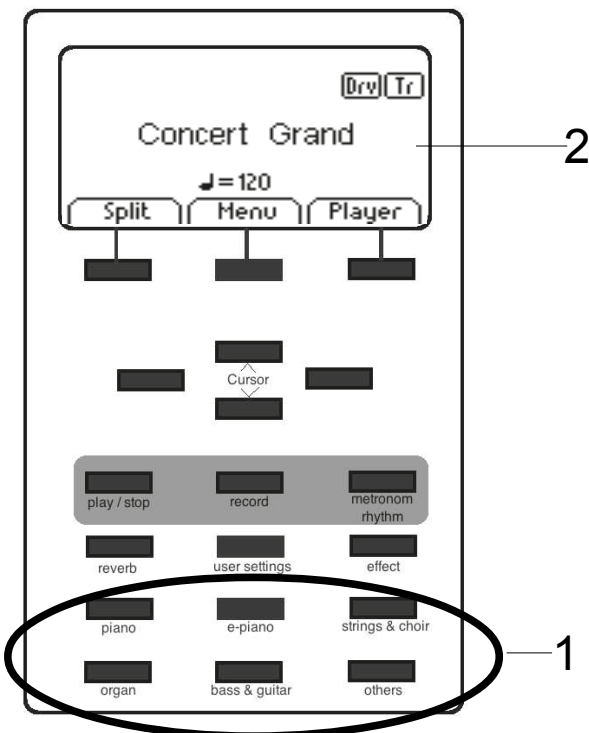

Repeatedly press the sound group buttons or use the right/left cursor buttons to browse through the various sounds within a group.

The selected sound will be shown on the display (2).



TIPP

We recommend you to use the demo songs to get an impression of how a sound can be played. Experience the sounds and be inspired by listening to the demo songs and playing the sounds on your own.

5.3.1 SOUND COMBINATION (DUAL SOUNDS)

Your GEWA digital piano can be set to play two simultaneous sounds in a layered mode. In the following we will show you how to do this:

(Select, as described on the previous page, a sound).

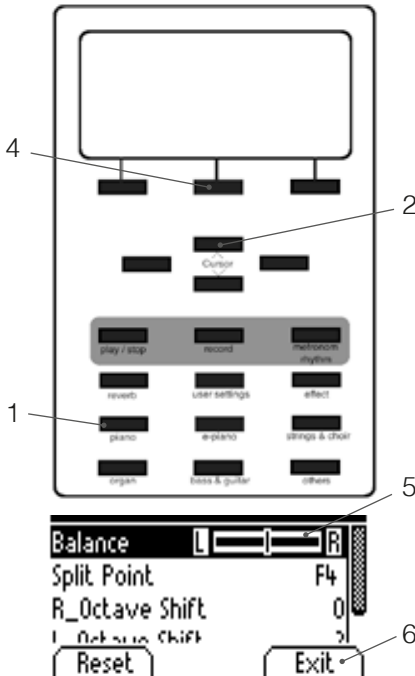

1. Hold a sound group button depressed and choose a sound from another group (or the same e.g. Strings & Choir)
2. With the up/down cursor buttons you know decide which one of the two you would like to exchange.
3. If you now play the keyboard you will hear both sounds simultaneously.
4. Hit the edit button to change the volume ratio of the two sounds.
5. Navigate to the balance settings and change the ratio to your preferences by using the left/right cursor buttons.
6. Use the "EXIT" softbutton to leave the menu

5.3.1 SOUND COMBINATION (SPLIT SOUND)

The UP 260 G can be set to playing two sounds in split mode, meaning, below and above the keyboard split point there will be two zones with different sounds. In the following we will show you how to do this:

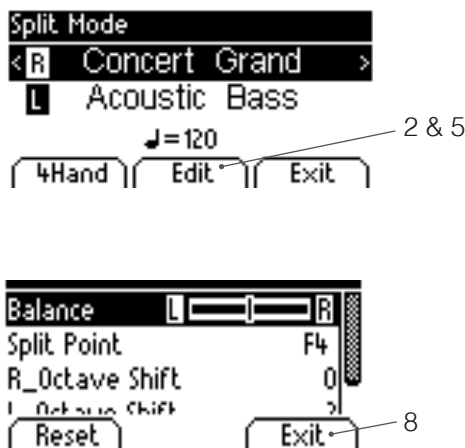

1. Select a sound as described above
2. Press the EDIT Softbutton
3. With the up/down cursor buttons you know decide which one of the two you would like to exchange.
4. If you now play the keyboard you will hear a dedicated sound for the left and right side of the splitted keyboard
5. Hit the edit button to change the volume ratio of the sounds..
6. Navigate to the balance settings and change the ratio by using the left/right cursor buttons.
7. By navigating to Split Point you can define the two dedicated keyboard zones for split sounds
8. Use the "EXIT" softbutton to leave the menu

5.4 REVERB AND CHORUS

Your digital piano has the possibility to mix in various special effects to the sounds with the reverb or chorus & others feature

- Some sounds already feature a factory preset reverb or chorus effect making the sound more lively and realistic.
- By pressing the reverb and/or chorus & others button you can deactivate or activate the effects as described.
- The edited effect settings remain active until the digital piano is switched off. When the instrument is switched back on, all factory settings are set back to their factory default values .

5.4.1 REVERB

The reverb (or hall-) effect simulates the sound in various room environments.

Your digital piano comes with the following reverb effects:

Display reading	Description
Room 1	Sounds like in a medium size living room
Room 2	Simulates a slightly larger room
Stage	Stage type experience
Hall 1	Concert Hall
Hall 2	Larger Concert Hall

Press the reverb on/off button to activate or deactivate the effect. The reverb-Effect is active when the LED light of the reverb button lights up. If the reverb function has been activated the effect type is shown in the display.Changes become effective immediately.

To edit the reverb effect, please press and hold the reverb button down until this reading is shown in the display. The up/down cursor buttons are then used to navigate to the desired edit item

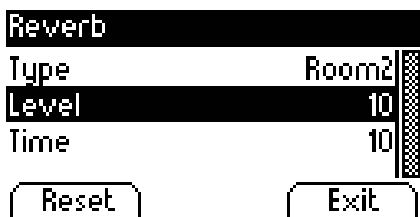

- "Type" lets you select a reverb preset.
- "Level" determines the volume ratio level to the sound
- "Time" defines the size of the simulated room

Use the "EXIT" softbutton to leave the menu

5.4.2 CHORUS AND OTHER EFFECTS

The chorus-function contains the following effects:

Name	Description
Chorus	Adds an ensemble effect to the sound
Tremolo	Volume modulation
Pan Tremolo	Like (Tremolo), but more intense
Phaser	Similar to a chorus effect with a slight frequency phase modulation
Rotary	Rotary speaker cabinet simulation. Perfect with organs

Press the chorus & others on/off button to activate or deactivate the effect. The chorus & others Effect is active when the LED light of the chorus & others button lights up. If the chorus & others function has been activated the effect type is shown in the display. Changes become effective immediately.

To edit the chorus & others effect, please press and hold the chorus & others button down until this reading is shown in the display. The up/down cursor buttons are then used to navigate to the desired edit item

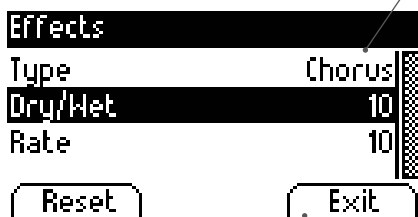

- "Type" lets you select a chorus & others preset
- "Dry/Wet" determines the volume ratio level to the sound
- "Rate" defines the speed of the modulation

Use the "EXIT" softbutton to leave the menu

5.5 METRONOME

Your digital piano has abuilt in metronome which supports you in keeping the rhythm. The metronome features 8 different typical metronome style and another 8 more complex drum accompaniment style beats. The metronome tempo can be adjusted and set from 10 to 400 bpm beats per minute.

5.5.1 SWITCHING THE METRONOME ON/OFF

1. Press the metronome button, the metronome button LED lights up.
The metronome is now activated.
2. By again depressing the metronome button the LED light will go off.
The Metronome is now deactivated.
3. As listed in the following chart, the metronome features two kids of beats:
 - Typical metronome beats as a rhythmical rehearsal support
 - Modern drum accompaniment grooves

The following presets are available:

Beat	Description
1 / 4	Typical Metronome Support Beat
2 / 4	Typical Metronome Support Beat
3 / 4	Typical Metronome Support Beat
4 / 4	Typical Metronome Support Beat
5 / 4	Typical Metronome Support Beat
3 / 8	Typical Metronome Support Beat
6 / 8	Typical Metronome Support Beat
12 / 8	Typical Metronome Support Beat
Rock	Drum Accompaniment Groove
Swing	Drum Accompaniment Groove
Funky	Drum Accompaniment Groove
Deep 90's	Drum Accompaniment Groove
Kick it	Drum Accompaniment Groove
Pop 80's	Drum Accompaniment Groove
Blues	Drum Accompaniment Groove
Jazz	Drum Accompaniment Groove
Acid	Drum Accompaniment Groove
Lounge	Drum Accompaniment Groove

5.5.2 CHANGING THE METRONOME SPEED

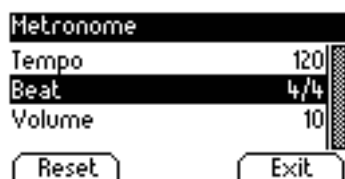

1. Press and hold the metronome button until you see what is displayed on the left
2. Use the up/down cursor buttons to edit Tempo, Beat and volume.
3. Press reset to instantly return to the previous settings. Changes become effective immediately. After switching the piano off and back on again, all edited values will be reset to default
4. Use the "EXIT" softbutton to leave the menu

5.5.3 BEAT TYPE CHANGES

1. Press and hold the metronome. The display will show the current beat in use
2. Use the up/down cursor buttons to navigate to the "beat" edit line. You can then change the beat by toggling the left/right cursor buttons
3. Press reset to instantly return to the previous settings. Changes become effective immediately. After switching the piano off and back on again, all edited values will be reset to default
4. Use the "EXIT" softbutton to leave the menu

5.5.4 SETTING THE METRONOME VOLUME

1. Press and hold the metronome. The display will show the current beat in use
2. Use the up/down cursor buttons to navigate to the "volume" edit line. You can then change the volume by toggling the left/right cursor buttons
3. Press reset to instantly return to the previous settings. Changes become effective immediately. After switching the piano off and back on again, all edited values will be reset to default
4. Use the "EXIT" softbutton to leave the menu

5.5.5 SETTING THE METRONOME VOLUME

1. Press and hold the metronome. The display will show the current beat in use
2. Use the up/down cursor buttons to navigate to the "volume" edit line. You can then change the volume by toggling the left/right cursor buttons
3. Press reset to instantly return to the previous settings. Changes become effective immediately. After switching the piano off and back on again, all edited values will be reset to default
4. Use the "EXIT" softbutton to leave the menu

6 FUNCTION MENU



NOTE

- 1 All the edited settings are reset to factory settings when the digital piano is switched off and back on again.

In the function menu you can edit numerous settings.

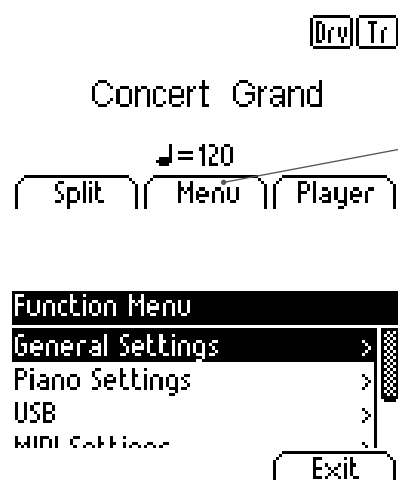

In the following we will show you how to access the FUNCTION menu

1. Press and hold the metronome. This will take you to the following menu
2. Press the up/down cursor button to navigate through the various edit functions
3. By pressing the right cursor button you are either directed to a submenu or you can directly change values.
4. Changes become effective immediately. After switching the piano off and back on again, all edited values will be reset to default.
5. Use the "EXIT" softbutton to leave the menu

Display	Main menu	Sub menu	Values
PLAYER	USB Player Menu	USB Song Select	--laut Datei Ordner---
	Play Mode		
	Song Volume		
	Song Transpose		
	Key Transpose		
Menu			
General Settings	Brilliance		Mellow, Flat, Bright
	Keyboard Transpose		-12/+12
	Tuning		427,0-453,0
	Max Phones Level		0-20
	Input Volume		0-20
	Input Reverb		0-20
	Startup Setting		Single, Repeat, Repeat All
	Piano Information		-----nur Info-----
Piano Settings	Keyboard Response	Curve	Constant, Soft1, Soft2, Medium, Hard1, Hard2
		Minimum Touch	1-20
		Constant Velocity	0-127
	Sustain Pedal	Half Pedal Point	0-20
		Damper Resonance	0-20
	Sympathic Resonance		0-20
	Temperament		Equal, Pythagorean, Pure Major, Pure Minor, Mean Tone, Werckmeister, Kirnberger
	Root Note		C-Bb
USB Menu	USB Player Menu	USB Song Select	--laut Datei Ordner---
	Load Song		--laut Datei Ordner---
	Load Lesson Book		--laut Datei Ordner---
	Load Registration		--laut Datei Ordner---
	Save Song	USB Destination	--laut Datei Ordner---
		Int Destination	--laut Datei Ordner---
	Save Registration	USB Destination	--laut Datei Ordner---
	Delete File		--laut Datei Ordner---
MIDI Menu	Transmit Channel		1-16
	Local Control		On/off
	Program Change		On/off
	Piano Mode		On/off
System	Display	Backlight	0-20
		Contrast	0-20
		Invert	On/off
	Auto Power Off		Off/15/30/90/120 min
	Registration Restore		!!!WARNING!!!
	Default Restore		!!!WARNING!!!
Recorder	Song Player	Volume	1-20
		Tempo	10-120
	Recorder	Track	1-2
		Song	1-4
		Key Transpose	-12/+12

6.1 BRILLIANCE SETTING

The brilliance settings can be used to achieve an even brighter or less brighter sound

This is how it is done

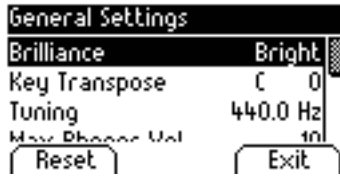

1. Enter the FUNCTION menu by pressing the menu soft button
2. Press the right or left cursor button to reach the desired brilliance setting
3. Use the "EXIT" softbutton to leave the menu

6.2 KEYTRANSPOSE

If you need to adjust to the key another musician is playing in, you can simply achieve this by transposing your digital Piano.

This is how it is done:

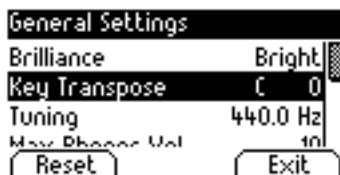

1. Enter the FUNCTION menu by pressing the menu soft button
2. Press the right or left cursor button to reach the desired transpose setting
3. Use the "EXIT" softbutton to leave the menu

6.3 FINETUNING

You can fine tune your digital piano in the following way:

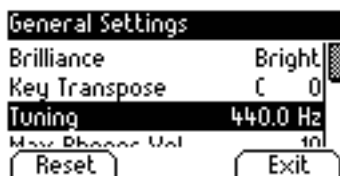

1. Enter the FUNCTION menu by pressing the menu soft button
2. Press the right or left cursor button to reach the desired fine tune setting
3. Use the "EXIT" softbutton to leave the menu

6.4 MAX PHONES LEVEL

With this function you can define the maximal headphones volume when the main volume slider of the piano is fully opened:

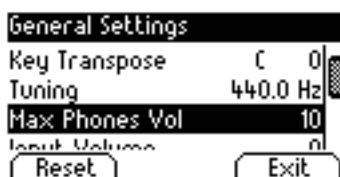

1. Enter the FUNCTION menu by pressing the menu soft button
2. Press the right or left cursor button to reach the desired phones level setting
3. Use the "EXIT" softbutton to leave the menu

6.5 INPUT REVERB

This function adjusts the reverb volume ratio to the played sound:

1. Enter the FUNCTION menu by pressing the menu soft button
2. Press the right or left cursor button to reach the desired input reverb setting
3. Use the "EXIT" softbutton to leave the menu

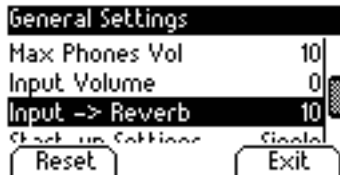

6.6 STARTUP SETTING

This function determines the behavior of the playback start button.

This is how it is done:

1. Enter the FUNCTION menu by pressing the menu soft button
2. Press the right or left cursor button to reach the desired input Start-up setting
3. Use the "EXIT" softbutton to leave the menu



6.7 PIANO INFORMATION

This information is useful when contacting the GEWA service staff :

1. Enter the FUNCTION menu by pressing the menu soft button
2. Press the right or left cursor button to reach the desired input Start-up setting
3. Use the "EXIT" softbutton to leave the menu

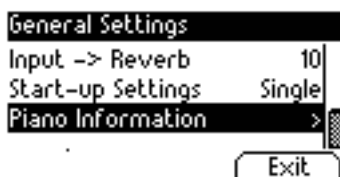

6.8 PIANO SETTINGS

This section deals with customizing your GEWA digital piano to your needs and personal preferences

6.8.1 KEYBOARD RESPONSE

The keyboard response defines how sensitive the piano reacts to your play on the keyboard. The softer this is set, the less force is needed to play louder tones. In this section we will show you how to edit these features:

1. Enter the FUNCTION menu by pressing the menu soft button
2. Press the up/down cursor buttons to enter the piano settings menu. Pressing the right cursor button will then take you to the various edit features
3. Use the left/right cursor buttons to change details as „curve“ (touch dynamics), Minimum Touch, or the value for a constant value (used e.g. for organs). You can play the key to test the setting while editing.
4. Use the “EXIT“ softbutton to leave the menu

The following Keyboard Response Settings are available:

- Medium: meets most needs for the average player
- Soft1: highly recommendable for beginners and children
- Soft2: like Soft1, slightly harder
- Hard1: for trained players
- Hard2: like Hard1 for players with an extremely forceful attack
- CONSTANT: without dynamics (especially recommendable for organ type sounds)

6.8.2 SUSTAIN PEDAL

With the sustain pedal functions you can change the sustain pedal characteristics in half-pedaling and damper string resonance behavior. This provides a highly realistic and vivid piano experience more than just having a pedal on/off functionality

These are the steps to edit this feature:

1. Enter the FUNCTION menu by pressing the menu soft button
2. Press the up/down cursor buttons to enter the sustain pedal settings menu. Pressing the right cursor button will then take you to the various edit features
3. Use the left/right cursor buttons to change the setting You can play the key and press the pedal to test the setting while editing.
4. Use the "EXIT" softbutton to leave the menu

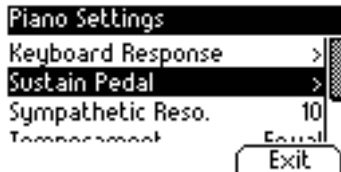

6.8.3 SYMPATHETIC RESONANCE

This feature allows you to change the sympathetic string resonance characteristic of your GEWA digital piano, giving it a highly realistic appeal in conjunction with your preference and the room the piano is used in

In the following we will describe how to edit this function:

1. Enter the FUNCTION menu by pressing the menu soft button
2. Press the up/down cursor buttons to enter the sympathetic resonance settings menu.
3. Use the left/right cursor buttons to change the setting You can play the key and press the pedal to test the setting while editing.
4. Use the "EXIT" softbutton to leave the menu



6.8.4 TEMPERAMENT / STIMMUNG

This feature allows you to tune your digital piano to other tuning temperaments than just „equal“. This is very useful when playing e.g. historical or special instruments like the Harpsichord. For which a high amount of musical literature was composed in these special temperaments.

Here is how it's done:



1. Enter the FUNCTION menu by pressing the menu soft button
2. Press the up/down cursor buttons to enter the sympathetic Temperament settings menu.
3. Use the left/right cursor buttons to change the setting (Equal, Pythagor., Pure Major, Pure Minor, Mean Tone, Werckmeister, Kirnberger) You can play while editing.
4. Use the "EXIT" softbutton to leave the menu

6.9 PLAYER MENU

Within the PLAYER menu you can edit the functions related to adding audio playbacks from a USB device (as listed on page 26). These functions are:

- (Play Mode): The way a playback is played
- (Song Volume): Volume of the playback in relation to your piano play
- (Song Transpose): Tonality adjustment to the key played on the piano
- (Key Transpose): Tonality adjustment to the key played on the piano



This is the way how it is done:

1. Enter the FUNCTION USB menu by pressing the menu soft button
2. Press the up/down cursor buttons to enter the USB settings menu, followed by a right cursor hit to access the submenu details.
3. Follow the instructions displayed and use, if required, the left/right cursor buttons
4. Use the "EXIT" softbutton to leave the menu

6.10 USB SETTINGS

The USB menu features the following adjustable functions:

- USB Player Menu: USB Song Select
- Load Song: Load song from a USB device
- Load Lesson Book: Load a lesson book (specially packaged e-learning file) from a USB device
- Load Registration: Load user settings
- Save Song: Save a song on an external USB device (e.g. USB stick)

Here is the way to do this

1. Enter the FUNCTION USB menu by pressing the menu soft button
2. Press the up/down cursor buttons to enter the USB settings menu, followed by a right cursor hit to access the submenu details.
3. Follow the instructions displayed and use, if required, the left/right cursor buttons
4. Use the "EXIT" softbutton to leave the menu

6.11 SYSTEM SETTINGS

The following settings are performed within the SYSTEM menu;

- Display: Parameter "Backlight"
"Contrast"
"Invert"
- Auto Power Off: The Piano switches off automatically within the set time frame
- Registration Restore: CAREFUL, all custom settings will be erased
- Default Restore: CAREFUL, all default defined settings will be returned to factory default settings

Here is the way to do this:

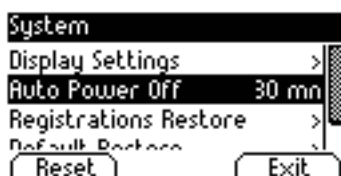

1. Enter the FUNCTION SYSTEM menu by pressing the menu soft button
2. Press the up/down cursor buttons to enter the SYSTEM settings menu, followed by a right cursor hit to access the submenu details.
3. Follow the instructions displayed and use, if required, the left/light cursor buttons
4. Use the "EXIT" softbutton to leave the menu

6.12 MIDI MENU

6.12.1 MIDI-TRANSMIT CHANNEL

With the MIDI-transmit channel you can determine on which MIDI channels (1-16) signals from your digital piano are transferred to or received from external MIDI devices.



This defines the MIDI channels for sounds being played on the right side of the key-split point and also for basic sounds in the Dual Sound mode before choosing the next layered sound. Sounds on the left side of the key-split and added layered sounds will be automatically fitted with the next available MIDI channel

Example:

If channel 4 is set as the MIDI-transfer channel, keys on the right side of the key-split point and base sounds in Dual Mode layered sounds are set to channel 4, while sounds on the left side of the key-split point and sounds added to the base sounds of a layered Dual mode sound are then transferred on channel 5.

Use the "EXIT" softbutton to leave the menu

6.12.2 LOCAL CONTROL

The local Control-Function enables you to mute the built in speakers of your digital piano, while signals are still transferred via MIDI OUT-connection.



This is very useful if you would like to control/play another instrument from the keyboard off your digital piano without, at the same time, hearing the sound of the digital piano.

Use the "EXIT" softbutton to leave the menu

6.12.3 PROGRAM CHANGE

The program change function lets you change a sound program on a MIDI connected instrument from your digital piano, or lets you receive and process a program change command.



Use the "EXIT" softbutton to leave the menu

6.12.4 PIANO-MODUS

In the piano-mode you determine how incoming MIDI data of channels 1 and 2 are processed.

If the Piano-Mode is switched (ON), channels 1 and 2 are enriched with Piano compatible effects, if a piano sounds is selected.

The Chorus-Effect is not available for channels 1 and 2 when the piano mode is activated. For channels 3-16 there is no piano effect available except for the GM-Chorus. If the piano mode is deactivated, the piano effect is not available for any of the 16 MIDI channels. Still the the GM-Chorus-Effect can be added on to all channels.



NOTE

By default the Piano Mode is set to “ON”

6.13 REGISTRATIONS

Your GEWA UP 260 G Digital Piano can store up to 3 banks (A, B & C), 6 presets of user defined sound combinations. These settings support you to maintain your most favorite instrument settings. These are, amongst various others, a few examples of possibly registrable functions:

- Sounds inc. effect settings
- Combined, dual sounds with all custom settings
- Split sounds incl the keyboard split point
- MIDI settings, as MIDI Transmit Channel, Program Change, etc.
- Transpose, Temperament and Fine Tuning
- System settings, as Contrast, Backlight, etc.

After modifying your sounds you have room for 18 settings/registrations in total, organized in 3 banks (A, B, C) and 6 slots each:

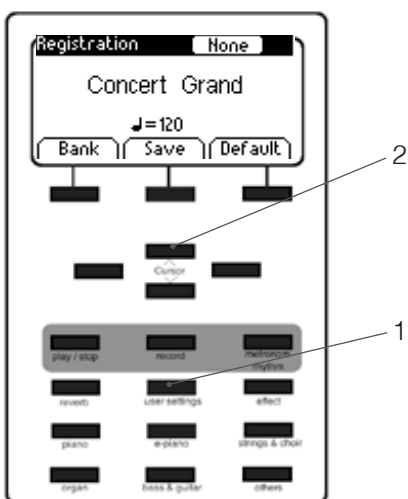

1. Press the “USER SETTINGS” button
2. Select your storage location from A1 to C6
3. Repeat this if you like for more registrations
4. Use the “EXIT” softbutton to leave the menu

7 RECORD AND PLAYBACK FUNCTION

Your GEWA digital piano can record your playing. It can store up to 4 pieces of music.

7.1 CHOOSE THE RECORDING MODE

To activate the recording mode please follow these steps:

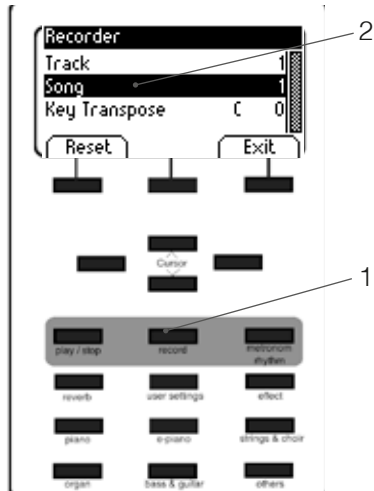

1. Enter the song select menu by pressing the record button.
2. You can now select the recording location 1-4 with the left/right cursor buttons
3. You can now begin your playing. The recording will start instantly after playing the first note. The metronome can be used to support your recording, but will not be recorded
4. Per song you have 8 tracks available. Any track can be recorded over and over until you are satisfied with the result
5. Use the "EXIT" softbutton to leave the menu

7.2 RECORDING SONGS



NOTE

Recorded songs are not automatically erased when switching your digital piano off. You may need to erase a song if all storage locations are already occupied. Follow the steps as described on "Erasing of recordings".

Proceed as follows when recording your playing:

1. Choose a recording file.
2. Once you've chosen a recording file the LED of the REC button lights up while the LED of the Play/Stop button is blinking.
3. By starting to play on the keyboard the recording will automatically start with the first note being played.
4. Press the Play/Stop-key to stop the recording. The recording is automatically filed.

7.3 PLAYBACK OF RECORDINGS



NOTE

There must already be stored recording before starting a Playback. Therefore please choose the relevant recording file. While a recording is being played back you can play along with the recording.



TIP

A fantastic way to play four hand literature with a virtual second player

1. Select the recording (see above).
2. Press the Play/Stop button, to start the play.
3. Press the Play/Stop-key again, to stop the playback.

7.4

EDITING RECORDINGS

This is how it is done::

1. Select a used recording location.
2. Hit the Edit Softbutton. The following editing details are now available:
 - Track mute
 - Song
 - Delete Song
 - Transpose Keyboard
 - Transpose Song

To now e.g. delete a song simply navigate to the function delete song using the up/down cursor buttons. Be sure that you have selected to right song and then press the right cursor button to delete the song or the left button to abort the deletion.



TIP

You can save your recordings to an external USB device. Here's how it's done:

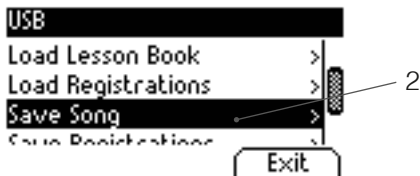

1. Enter the FUNCTIONS menu by pressing the menu soft button. With the up/down Cursor buttons you can then navigate to USB Settings.
2. Then scroll down to „Save Song“. Follow the instructions displayed and use, if required, the left/right cursor buttons
3. Use the “EXIT“ softbutton to leave the menu

8

CONNECTING PERIPHERALS

Here you can learn more about the connection options for your GEWA digital piano.

8.1 CONNECTING HEADPHONES

Connect one or two headphones to the two 6.3 mm jack connectors under the console.



NOTE

If headphones are connected to either one of the headphone output connectors, the speakers of your GEWA digital piano are automatically deactivated and will only be reactivated after you have removed the headphone/s. Make sure both connectors are unplugged.

8.2 CONNECTING A PLAYBACK DEVICE

You can connect playback devices such as e.g. a CD or MP3 player to your digital piano. This can be helpful when you are rehearsing a song in Playback mode. When properly connected you will be able to hear both, the piano and the Playback device either through the piano speakers or connected headphones. You can control the volume balance easily with the volume control.

8.3 CONNECTING AN AMPLIFIER

If you need your digital piano to play louder than with the built in speakers, you can easily connect it to an amplification system using the LINE OUT outputs under the console.

8.4 CONNECTING A PC

You can link your digital piano with your PC with the USB-B connection under the console.

This is how you can link your PC with your digital piano:

1. Switch off your digital piano and the PC.
2. Connect your digital piano with your PC with a certified USB lead.
3. Switch on your digital piano and the PC.

Your digital piano will be automatically recognized by your PC. There are various appropriate software tools (e.g. recording software) on most available operating system platforms and devices with which you can enjoyably extend your musical experience.



NOTE

To check the details on the data exchange between your digital piano and the PC, it is recommended that you use the PC software provided monitoring tools.

8.5

BLUETOOTH AUDIO

The GEWA UP series digital pianos feature a Bluetooth Audio interface which can be used to play back audio from external Bluetooth devices

In the following we will explain how this is done:

1. Enter the bluetooth menu of your player device and search for your GEWA digital piano.
2. After the piano is displayed simply press „connect“
3. Now your GEWA digital UP piano is enabled to play audio files deriving from your playout device through the built in speakers.

9

USEFUL INFORMATION

At this point we would like to explain a few terms that are used in our user manual. Additionally we explain the special features of your digital piano.

9.1

EXPLANATION OF TERMS

Term	Definition
MIDI	<p>Musical Instrument Digital Interface is a data transfer protocol. With this, musical control information is transferred between electronic instruments such as digital pianos, keyboards, synthesizers, drum computers or even PCs or laptops. To exchange this control information, the instruments/ computers require MIDI connections and a link must be established between them. There are different MIDI connections with various functions: MIDI-IN (input), MIDI-OUT(output) and MIDI-THRU. The last one routes received data untouched from MIDI to be used for other MIDI device. Here's an example:</p> <p>If a key on the digital piano is pressed, digital data packets are sent from MIDI In to MIDI out (MIDI-OUT). The data packets contain information on pitch, keyboard dynamic and the duration of the keystroke. The data packets output can be e.g. recorded, stored, played back on the computer and also displayed as notation on the screen if the application is able to do this.</p> <p>Recorded MIDI data can then be sent to a MIDI instrument, e.g. a digital piano, to make it audible again.</p>
GM	<p>General MIDI defines a lot more than what is defined in the basic MIDI protocol. It combines hardware and protocol specifications. General MIDI also specifies content. For this, GM sets a minimum standard for the assignment of the instruments to 128 program places. According to GM, a compatible GM MIDI instrument must be able to generate 24 sounds simultaneously. Furthermore, according to GM, additional control parameters are defined, such as e.g. effect control.</p>
General MIDI standard sounds	<p>Sounds or instruments in compliance with the specifications of the General MIDI standard protocol</p>
Reverb	<p>This simulates a room environment. It is preconfigured for some sounds to give them a more lively and realistic appeal.</p>
Chorus	<p>The chorus effect adds another slightly detuned note to every note that is played. This produces a fuller ensemble like impression.</p>
Samples	<p>Samples are audio clip recordings from natural instruments. All sounds of sampled instruments are recorded and saved to logically defined locations. This then leads to an organized sum of sampled single notes, which, when played back, sound like the originally sampled natural instrument.</p>
Polyphony	<p>Maximum number of simultaneously playable notes. A high number of simultaneously playable notes ensure a highly natural sound impression.</p>

9.2

WARRANTY

Warranty for a period of 2 years from the date of purchase on hardware and workmanship is granted by the dealership where the digital piano was originally bought. In the event of a defect the buyer has in the first instance, exclusively the right receive a supplementary performance. Supplementary performance includes either rectification or supply of a replacement product. Equipment or exchanged parts become to be the property of the processing dealership.

In the event the rectification should fail, the buyer may demand a reduction on the purchase price or withdraw from the contract and, if the dealership is responsible for the defect, demand compensation for damages and/or expenses deriving from the defect(s).

The buyer must inform the dealer immediately on any defects identified. The only way to prove a warranty claim is that the buyer can present a valid proof of purchase, e.g. invoice. Damage arising from incorrect handling, operation or storage as well as by force majeure or other external influences, does not comply with the warranty terms, nor in addition does the use of consumer products such as e.g. rechargeable batteries, strings, skins or seals.

If you suspect to have a claim covered by the warranty terms regarding your GEWA digital piano, please contact your dealer during regular business hours.

10

TROUBLESHOOTING AND POSSIBLE SOLUTIONS

With the tips listed here you can possibly fix occurring faulty behavior of your digital piano on your own. Should your efforts still not be successful please contact your next specialized dealership.

POSSIBLE CAUSE AND SOLUTION

Defect	Possible cause	Possible solution
The device can not be switched on	<ul style="list-style-type: none"> • The mains plug is not plugged in • The mains adapter is not correctly connected 	<ul style="list-style-type: none"> • Check the mains adapter and its connections. If necessary reconnect it..
Clicking noise when switching on/off	<ul style="list-style-type: none"> • This is normal and can happen when the digital piano is switched on and off. 	
Static noise comes from the speakers during operating	<ul style="list-style-type: none"> • Interference with other devices (e.g. mobile phones). 	<ul style="list-style-type: none"> • Increase the distance between the digital piano and the other devices or switch the other devices off.
The sound is much too quiet or cannot be heard at all.	<ul style="list-style-type: none"> • The volume control is set too low. 	<ul style="list-style-type: none"> • Set the volume control louder. Headphones are connected. • Remove the headphones.
The pedals do not function correctly	<ul style="list-style-type: none"> • The pedal cable is not connected properly. 	<ul style="list-style-type: none"> • Check if the pedal cable is firmly connected to the socket. • If necessary reconnect it.

11

TECHNICAL DATA

Name	Feature
Dimensions WxDxH (with musical sheet rest)	146,2 x 42 x 92,8 (109)cm
Weight	60 kg
Power input	max 75 Watt
Keyboard	88 keys, weighted, Fatar Graded Hammer System, wooden key core (WK)
Attack dynamic	6 levels (Soft1, Soft2, Medium, Hard1, Hard2 and Constant)
Pedals	Soft-, Sostenuto- and Piano-Pedal
Sound source	GEWA music Samples 6-Layer
Polyphonie	Max. 256 tones
Number of internal sounds	37
Amplifier output RMS	2 x 20 Watt
Speakers	2 pcs Fullrange-Stereo-speakers
Recording function	integrated 8 track recorder
Recording format	Standard MIDI-file (Format 0, SMF)
Connections	<ul style="list-style-type: none"> - Connection for mains adapter - MIDI IN - MIDI OUT - Aux In - Aux Out - 2 x Headphone sockets (6,3 mm jack) - USB Type B - USB Type A

Manufacturer:
GEWA music GmbH
Werkstraße 1
08626 Adorf
GERMANY
www.gewamusic.com
Version 1.0



changes and errors excepted